

For Mamiya and Bronica medium format cameras and accessories go to : www.ianbfoto.com



ZENZA BRONICA ETRS

Complete System Camera, with 35mm Handling Speed and Operating Ease.

The Multi-Format Camera

www.ianbfoto.com



**Zenza Bronica ETRS—
The System Camera Known for
High Image Quality and Handling Speed.**



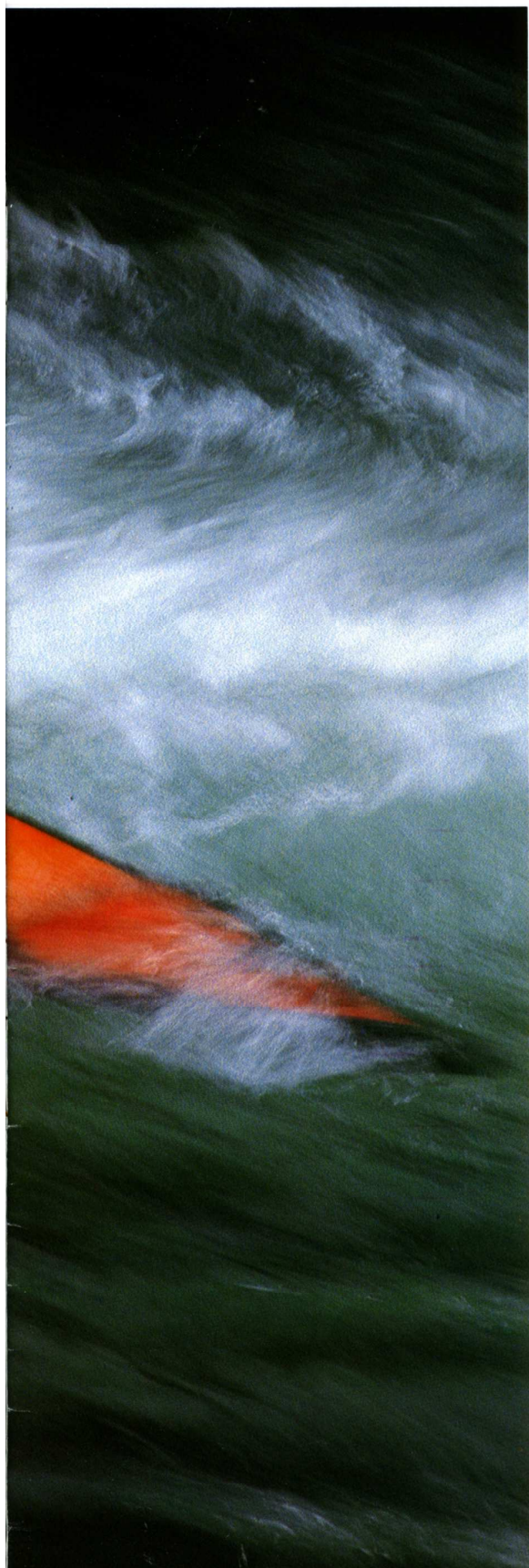

Large Frame Size Increases Power of Expression

The 6x4.5cm format has a large frame size which is about 2.7 times larger than the 35mm format. The larger frame size is, of course, more advantageous for obtaining better image quality and when increasing magnification for making larger prints. And, the large negative area is very effective for obtaining outstanding prints in which sharp, natural and subtle details are beautifully expressed. Moreover, the larger finder area also makes it possible to carefully check the corners of the frame and the image information required for the picture.

Compact "System" Camera with 35mm Handling Speed

The ETRS is compact "system" camera with the handling speed of the 35mm camera. This means that it has managed to combine the merits of "mobility and portability" (which are not the usual merits of the large format camera) with the advantage of the large frame size. The ETRS is based on a design concept of advanced micro-electronics, with greater miniaturization and more electronics in its various parts. The ETRS also incorporates a newly-developed lens shutter which has made possible a more compact and lightweight camera, with increased precision by incorporating electronics in various camera functions. A complete "system" effect was also one of its principal objective and, therefore, the camera also has highly advanced interchangeability of its parts. In other words, lenses, finders, film backs and focusing screens can be exchanged quite freely, with various optional accessories available for different kinds of photographic work. This means that highly individualized camera "systems" are possible, including a choice of automatic exposure, automatic winding, remote control operations, close-ups, motorized operations, etc.

Originality Born from Exclusive Mechanisms

The ETRS also has the operational ease of the medium format camera, with simple lever operation for changing to multiple exposures. This means that one image can be placed on top of others very easily for building up a new photographic image or used as a form of expression. Such forms of expression can result in very unique images, for producing original pictures or simply used for one's own pleasure.



Multi-Format Zenza Bronica ETRS— Changes the Image of the Medium Format Camera.

1 Greater Handling Speed with a Compact, Lightweight “System” Camera.

The high image quality of the medium format plus superior operating ease and greater handling speed has been made possible because of a basic design for a lightweight, compact main camera body, to which various parts are added to match the user's need in the medium format. The ETRS, in other words, is the result of Bronica's constant effort to give the medium format user the handling speed and operating ease of the 35mm camera.

2 Lens Shutter Interchangeable Lenses, with Superior Color Balance and Sharpness.

The specially-designed Zenzanon-E lenses are noted for their high image depiction characteristics and superior color balance. The very compact lens design incorporates a Seiko #0 between-lens shutter, with the electronic control mechanism in the main camera body, which also provides full flash synchronization at all shutter speeds. Lenses from 40mm to 500mm, plus 2x teleconverter and close-up accessories are available.

3 Finders to Match the Shooting Mode.

Finder interchangeability means there's a choice of waist-level or eye-level view-focusing, and even low-angle shooting. The AE-II Finder is popular because it is not only suitable for horizontal and vertical formats but also increases handling speed and can be used for both aperture-priority AE or manual exposure controls. And, a Rotary Finder for reflex viewing of a laterally-correct upright image is also available.

4 Multi-Format System Permits Changing Films and Formats at All Times.

The ETRS has a very simple film back changing system, for using 120 and 220 roll films (6 x 4.5cm), 135 roll film (24 x 36mm and 24 x 54mm) and Polaroid Land pack film. Film backs can be changed any time, even in mid-rolls and in daylight, when conditions change or there are changes in working plans.

5 Choice of Three Winding Systems.

There is a choice of three winding systems; single rotating film winding crank on the main camera body, two stroke lever winding on the Speed Grip and simple Motor Drive operation, with choice of single frame or continuous shooting, as well as remote control operations. And, hot shoes on the optional accessories accept electronics flash units.



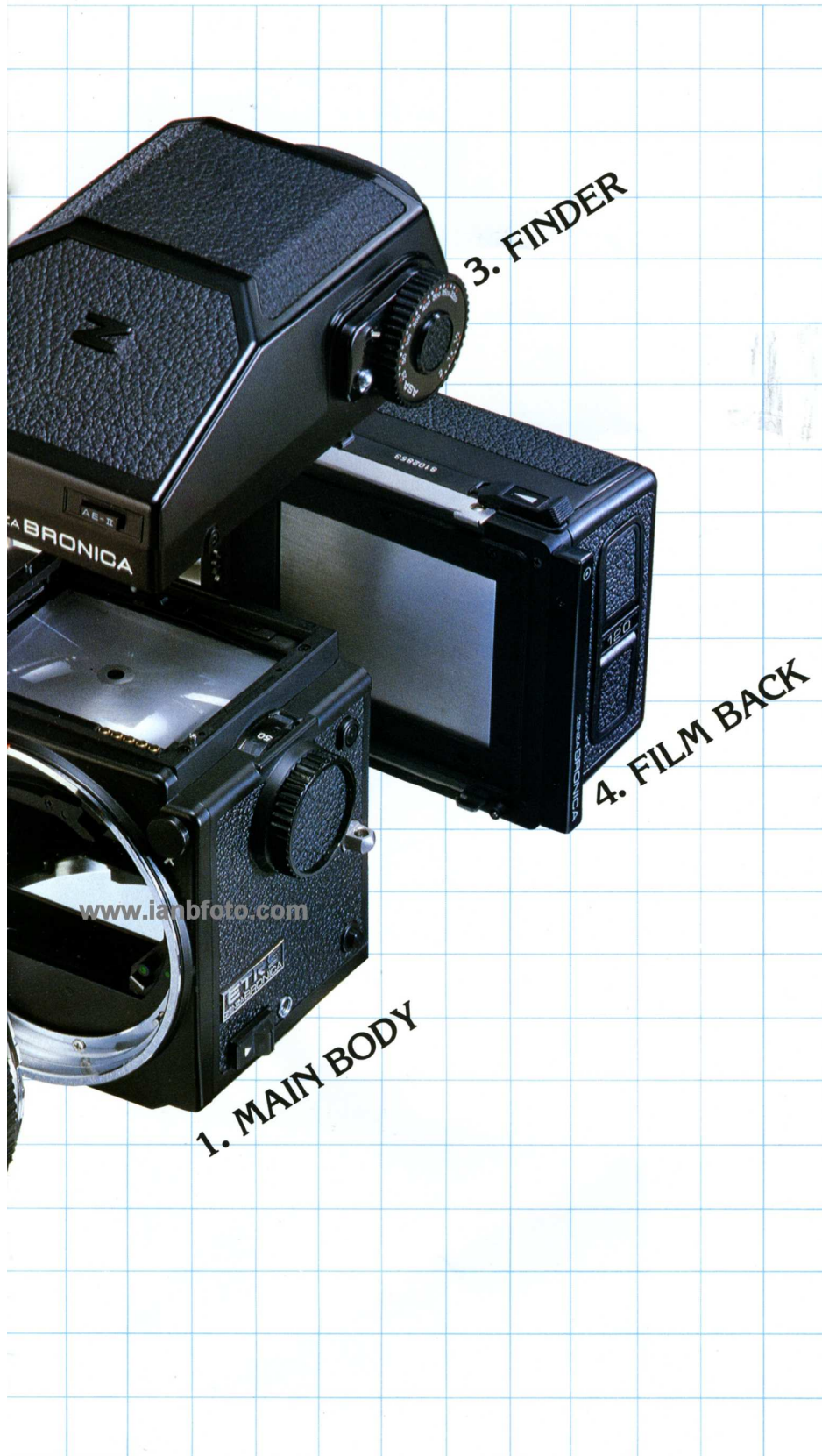

- The Motorized & AE Set-Up



- The Low-Angle Set-Up



- The AE Set-Up



- The Macrophotography



- The Polaroid Set-Up



Speedy-handling, Easy-operating Bronica ETRS— Results from a Pursuit of Rational Operations.



Choice of Two Shooting Modes.

Shooting in either waist-level or eye-level is possible by simply changing finders. The easy-to-view waist-level finder is one of the merits of the medium format.



Choice of Aperture-Priority Auto-Exposure or Manual Control.

With the AE-II Finder E, TTL Aperture-Priority exposure metering is possible, by simply switching the dial to "A" on the finder.

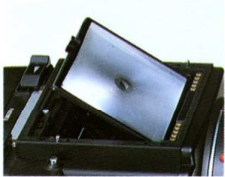

Bright, Easy-Viewing Finders.

Bronica finders are recognized for their brightness, with a compression type focusing screen, while prism finders have a specially-designed total reflection prism system which gives it extra brightness and superior durability. And, finder magnification has also been increased for easy viewing.



Electronic Control Lens Shutter, with Shutter Release Lock.

The shutter speed dial has settings from 1/500 to 8 seconds, with the shutter release electronically controlled and synchronizing with electronic flash at all shutter speeds. A red LED lights up below the screen area when there is normal operations while a shutter release lock is available for preventing accidental releases.



Easy Film Winding System.

- (1) Single forward rotating film winding crank, which can be rotated from any position, with ratcheted action also possible.
- (2) Lever winding action, when the Speed Grip E is attached. (Two winding actions.)
- (3) Film winding with the Motor Drive E is also possible.





- 1 Film speed dial index
- 2 Film speed scale
- 3 Battery check button
- 4 Rubber eyecup
- 5 Spool holders
- 6 Depth of field preview lever
- 7 Shutter speed dial
- 8 Lens release button
- 9 Cable release socket
- 10 Film back release button
- 11 Film winding lever
- 12 Focusing screen
- 13 Back cover release button (right)
- 14 Exposure counter
- 15 Shutter speed scale
- 16 Shutter speed dial
- 17 Back cover release button (left)
- 18 Accessory shoe
- 19 Shutter release button
- 20 Flash synch socket
- 21 Film winding crank
- 22 Multiple exposure lever
- 23 Shutter release button
- 24 Aperture ring
- 25 Depth of field scale
- 26 Distance scales
- 27 Focusing ring
- 28 Manual film winder
- 29 Neck strap stud
- 30 Contacts
- 31 Flash synch contact
- 32 Motor drive contacts
- 33 Speed grip shutter release connection
- 34 Shutter release button locking ring

Specifications of the ZENZA BRONICA ETRS

Type	4.5cm x 6cm format lens shutter single lens reflex camera, with interchangeable lens, film back, finder and focusing screen systems.
Frame size	42.5mm x 55.1mm (side/length ratio of 1:1.29 closely matches standard paper and reproduction sizes)
Film	120 roll film (15 exposures); 220 roll film (30 exposures); 135 roll film in film cartridge; and Polaroid® Land pack films. (Exclusive film backs for each film type)
Standard lens	Zenzanon-EII 75mm F2.8 lens, interchangeable type; 6 elements in 4 groups; multi-layer anti-reflection coated; 49° angle of view, F22 minimum aperture, helical focusing from inf. to 60cm.
Filter size	φ62mm for 40—250mm lenses and φ95mm for 500mm lens.
Lens mount	Exclusive four claw Bronica ETR bayonet mount.
Lens diaphragm	Fully automatic instant reopening lens diaphragm action; equal-distant aperture scale graduations; depth of field previewing.
Shutter	Electronic control SEIKO #0 between-lens leaf shutter; shutter speeds 8 sec. to 1/500 sec. plus T (time exposures); intermediate settings are not possible, mechanical control setting 1/500 sec.
Multiple exposure	Multiple exposures possible with lever on main body.
Film back	Daylight loading interchangeable type; Exclusive film backs for 120, 220 roll and 135 roll film in film cartridge and Polaroid® pack film.
Finder system	Interchangeable finder system.
Focusing screen	Interchangeable type.
Flash synchronization	X-setting (up to 1/500 sec.)
Battery checking	Red-colored LED lights up within screen area when battery check button is depressed, if there is sufficient power; also LED flash signals upon closing of shutter blades.
Battery	Single 6-volt silver oxide or alkaline battery also powers AE-II finder E, when attached.
Dimensions	91(W) x 87(H) x 69(L)mm (ETRS Main body only) 91(W) x 107(H) x 165(L)mm (With Zenzanon-EII 75mm lens, Film Back ETRS 120 and Waist-Level Finder E)
Weight	465 grams (ETRS Main body only; without battery) 1,280 grams (With Zenzanon-EII 75mm lens, Film Back ETRS 120 and Waist Level Finder E; without battery)

The specifications are subject to change with or without prior notice.

**Zenzanon-E Lenses —
Result from a Constant Effort to Improve
Contrast, Color Balance and Image Reproduction
Performances.**



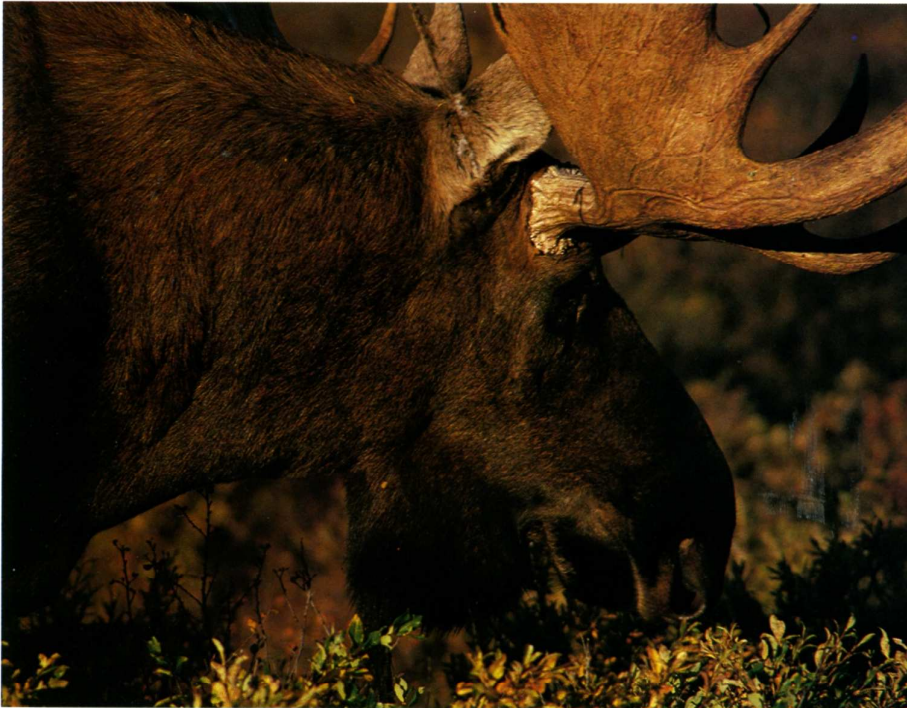

Electronic Control Lens Shutter System, with Flash Syncing up to 1/500 Second.

The use of electronic flash for taking pictures is very popular because the photographic range is greatly increased with the short flash illumination and fast recycling which makes continuous use possible. However, because of the very short high-speed flash, the focal plane shutter can only be used at top speeds of 1/60—1/125 sec., whereas the Bronica lens shutter system opens up fully, even at the top speed of 1/500 second, and makes flash sync possible at all shutter speeds. Daylight fill-in flash for shooting against the light and studio work with high-speed flash illumination are the strong points of the lens shutter system. And, shutter speed and lens opening can be freely adjusted, even with electronic flash, which opens up new photographic fields.



Zenzanon-E Interchangeable Lenses, with Fine Optical Performance.

A full range of interchangeable lenses is one of the prime prerequisites of a System Camera and Bronica has developed a full range of Zenzanon-E lenses, which have been designed as high performance, compact lenses, which take full advantage of the lens shutter system. The lenses incorporate a section which is opened or closed by signals received from the camera body and thus set shutter speeds from 1/500 to 8 seconds. The control system in the camera body is activated by various informations transmitted to it, while the Zenzanon-E lenses have terminals on their rear ends for receiving the signals from the camera control circuit. Lenses from 40mm to 500mm, as well as 2x tele-converter, bellows and extension tubes, are available for the ETRS System.



Specifications of Zenanon-E Lenses

Zenanon-E	40mmF4	50mmF2.8	E II 75mmF2.8	105mmF3.5	150mmF3.5	200mmF4.5	250mmF5.6	E II 500mmF8
No. of group-element	8 - 10	8 - 9	4 - 6	4 - 6	5 - 5	5 - 5	5 - 5	6 - 7
Angle of View	82°30'	70°	49°	37°	26°30'	20°	16°	8°
Aperture Range (F)	4 ~ 22	2.8 ~ 22	2.8 ~ 22	3.5 ~ 22	3.5 ~ 22	4.5 ~ 32	5.6 ~ 32	8 ~ 45
Min. focusing distance (m)	0.4	0.5	0.6	0.9	1.5	2	3	8.5
Filter size (mm)	62	62	62	62	62	62	62	95
Length(mm)·Weight(grams)	53 · 515	51 · 480	51 · 450	66 · 570	73 · 625	103 · 700	141 · 840	267 · 1890
Equivalent focal length in 35mm format camera (mm)	24	30	45	63	90	120	150	300

The Tele-Converter E 2X doubles the focal length of the prime lens of 75mm~500mm, while preserving their minimum focusing distances. (Size : 53mm × φ83mm, Weight : 425 grams)

AE or Manual? Eye-level or Waist-level? The Right Finder is the Only Finder for Proper Picture-Taking.

Interchangeable Finder System— for Matching Requirements.

The Bronica interchangeable finder system gives the user a choice of AE or manual operations, or finders for matching the shooting mode, since it is, very important that proper finders be chosen for matching conditions, whether it is catching the proper mood or action.

AE-II Finder E



Shows bright, laterally-correct upright image, with choice of aperture-priority AE or manual operations. Shutter speed or over-/under-exposure warning is displayed below the screen area.



Specifications

Magnification	: 0.82x, with standard 75mm lens
Finder field	: 40.6 × 51.6mm (96% × 94%)
Exposure measurements	: TTL full aperture, with 2 silicon photocells; full area average reading; EV4~17 (at ASA/ISO 100)
Film speed range	: ASA/ISO 25~3,200
Shutter speed range	: 8~1/500 sec. (in stageless steps on Auto)
Exposure compensations	: Over- and Under-exposure adjustments possible up to one EV.
Finder indications	: Color-coded LED digital display of shutter speeds in yellow (8S~1/30 sec.), green (1/60~1/500 sec.) and red (over- and under-exposure warnings) below screen area, with half-stroke of shutter release button.
AE dial	: A (Auto)—AE circuit automatically controls shutter speed, with LED display in finder; M (Manual)—AE and body control circuits operate independently, with blinking LED display of recommended shutter speed; ● (Off)—AE circuit is switched off and body control circuit only is in operation, without any finder display.
Power source	: The 6 volt battery in the camera body is also used as the power source for the finder.
Magnifier	: -1.5 dptr supplied; can be exchanged for magnifier in -4.5 to +1.5 dptr range.
Size	: 82.5(W) × 125(L) × 53(H)mm with eyecup attached
Weight	: 380 grams

Rotary Viewfinder E

Eyepiece rotates 90° to the left/right, for reflex viewing in horizontal/vertical formats. Bright, upright image is laterally correct. Ideal for low-angle shooting.



Specifications

Magnification	: 0.81x, with standard 75mm lens
Finder field	: 40.6 × 51.6mm (96% × 94%)
Eyepiece adjustment	: 180° rotation, with click stops at 90° to left/right from the vertical
Magnifier	: -1.5 dptr supplied; can be exchanged for magnifier in -4.5 to +1.5 dptr range
Size	: 68(W) × 114(L) × 105.5(H)mm with eyecup attached
Weight	: 448 grams

Prism Finder E

Lightweight, compact eye-level finder, shows bright, laterally-correct, upright image. Good for horizontal/vertical formats.



Specifications

Magnification	: 0.82x with standard 75mm lens
Finder field	: 40.6 × 51.6mm (96% × 94%)
Magnifier	: -1.5 dptr supplied; can be exchanged for magnifier in -4.5 to +1.5 dptr range
Size	: 68(W) × 125(L) × 52(H)mm with eyecup attached
Weight	: 277 grams

Waist-Level Finder E

Lightweight, compact finder for general composition work. Single-action hood erection, with flip-up magnifier for critical focusing.



Specifications

Magnification	: 1.15x with standard 75mm lens; (Magnifier magnification is 3.85x)
Magnifier	: -1.5 dptr supplied; can be exchanged for magnifier in -4.5 to +1.5 dptr range
Size	: 69(W) × 63(L) × 17(H)mm
Weight	: 100 grams

Interchangeable Focusing Screens— for Matching Lens and Film Back.

Seven types of focusing screens are available for the ETRS and should be chosen on the basis of the lens, film back and/or picture-taking conditions. Simple, single action exchanges.

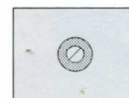

Microprism/Split-Image
Diagonally-oriented split-image with microprism ring; for general use.

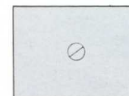

Split-Image
Central split-image spot; suitable for subjects with horizontal lines.

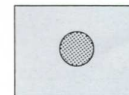

Microprism
Microprism spot for subjects without strong lines; for general use.



Matte
Central matte spot; for general use. Also for slow lenses/small apertures.

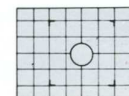

Grid-lines
Central matte spot and overall grid-lines. For composition work.

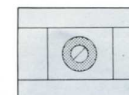

Microprism/Split-Image
For Film Back ETRS 135.



Matte
For Film Back ETRS 135.

Type of Finder	Eye-Level Viewing		Waist-Level Viewing	
	AE-II Finder E	Prism Finder E	Rotary Viewfinder E	Waist-Level Finder E
Item				
AE	○	×	×	×
Laterally-correct image	○	○	○	×
Vertical shooting	○	○	○	×
Magnification (with standard 75mm lens)	0.82	0.82	0.81	1.15

Multi-Format Bronica Film Back System— Provides Complete Freedom in Frame Sizes and Films.



Interchangeable Film Back System— for Single-Action, Daylight Interchanging.

The interchangeable film back system is a Bronica tradition which permits single-action interchanging of film backs and, therefore, film and negative size, for matching picture-taking requirements and conditions. Film backs are interchangeable quite freely, even in mid-roll and in daylight, which means that different types of films can be used intermixed, without the loss of a single frame, as long as there are enough extra film backs.

Bronica Inter-changeable Film Back System with Double Safety Features.

Double safety systems are built into the interchangeable film back system for preventing double exposures and blank film advances.

- Film winding crank stops automatically after one forward rotation, with film advanced and shutter cocked at the same time.



- Film back is not detachable without inserting dark slide and pressing release button. And, shutter will not work, without removing dark slide upon attaching film back.



- Back cover will not open unless two release buttons are pushed inwards but locks automatically when closed strongly.

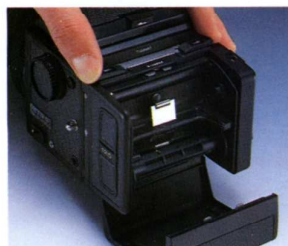

**6 × 4.5 Film Back ETRS 120
Film Back ETRS 220**



Exclusive film backs for 120 and 220 roll films provide improved film flatness, with 15 exposures available on the 120 and 30 exposures on the 220.



**24 × 54
Film Back
ETRS 135-W**



Exclusive film back for 135 roll film. Horizontally wide frame area which is about 1.5 times normal 35mm format.



**24 × 36
Film Back
ETRS 135-N**



Exclusive film back for 135 roll film. Wide variety of films available, from extremely fine grain to ultra high-speed.



**6 × 4.5
Polaroid
Film Back E**



Developed with the Polaroid Corporation and provides instant pictures for pre-checking light, composition and exposure.
Film type: 665, 667, 668, 669, 107, 108, 87 & 88.

Bronica ETRS Versatility— Increased with a Wide Range of Optional Accessories.



www.ianbfoto.com

Close-Up Lens EII



Simple close-up shooting when screwed on front of the lens. Exposure factor calculations are not required. Available in two focal lengths which can be used individually or together.

Zenzanon-EII 75mm F2.8	Distance Scale	Focusing Distance	Magni- fication	Area Covered
C.U.L. - 1 (f=50)	∞	63.9	0.15×	27.8 × 36.0
	0.6m	38.6	0.34×	12.6 × 16.4
C.U.L. - 2 (f=25)	∞	38.1	0.31×	13.7 × 17.8
	0.6m	30.6	0.50×	8.5 × 11.0
C.U.L. - 1 +	∞	30.4	0.46×	9.3 × 12.0
C.U.L. - 2 (f=17)	0.6m	27.1	0.65×	6.5 × 8.4

* The focusing distance is from film plane to subject. Unit: cm



Automatic Bellows Attachment E

Variable magnification changes, up to about 2x with the standard lens, are possible by simply inserting the accessory between lens and camera, with no changes in operations. And, there is full exposure automation with the AE-II Finder.

Lens	Bellows Extension	Magnification	Area Covered (cm)	Lens	Bellows Extension	Magnification	Area Covered (cm)
75mm	Min.	0.71×	5.99 × 7.76	150mm	Min.	0.37×	11.4 × 14.7
	Max.	2.18×	1.95 × 2.52		Max.	1.19×	3.59 × 4.65
40mm	Min.	1.32×	3.22 × 4.17	200mm	Min.	0.28×	15.0 × 19.5
	Max.	3.90×	1.09 × 1.41		Max.	0.92×	4.57 × 5.93
50mm	Min.	1.08×	3.92 × 5.08	250mm	Min.	0.23×	18.9 × 24.4
	Max.	3.20×	1.33 × 1.72		Max.	0.74×	5.74 × 7.44
105mm	Min.	0.53×	8.06 × 10.4				
	Max.	1.64×	2.58 × 3.35				

Automatic Extension Tubes E



Three tubes provide different extensions for simple close-up photography, without loss of automatic diaphragm action, full aperture exposure measurements and no changes in the shutter action.



Speed Grip E

Provides fast handling and speedy shooting of the 35mm camera and also makes shooting in the vertical and horizontal formats easy. Has film winding lever for shutter cocking and film winding, as well as shutter release and hot shoe.



Lens	Tube Used	Magnification	Area Covered (cm)
75mm	E-14	0.18~0.36x	23.5x30.5~11.7x15.1
	E-28	0.36~0.54x	11.8x15.2~7.8x10.1
	E-42	0.54~0.73x	7.8x10.2~5.9x7.6
40mm	E-14	0.34~0.51x	12.6x16.4~8.3x10.7
	E-28	0.67~0.85x	6.3x8.2~5.0x6.5
	E-42	1.01~1.19x	4.2x5.5~3.6x4.6
50mm	E-14	0.28~0.42x	15.4x20.0~10.1x13.1
	E-28	0.55~0.70x	7.7x10.0~6.1x7.9
	E-42	0.83~0.97x	5.1x6.7~4.4x5.7
105mm	E-14	0.13~0.29x	31.7x41.1~14.5x18.8
	E-28	0.27~0.43x	15.8x20.5~10.0x12.9
	E-42	0.40~0.56x	10.6x13.7~7.6x9.8
150mm	E-14	0.10~0.23x	44.6x57.9~18.8x24.3
	E-28	0.19~0.32x	22.3x28.9~13.2x17.1
	E-42	0.29~0.42x	14.9x19.3~10.2x13.2
200mm	E-14	0.07~0.21x	59.2x76.7~20.6x26.7
	E-28	0.14~0.28x	29.6x38.4~15.3x19.8
	E-42	0.22~0.35x	19.7x25.6~12.1x15.8
250mm	E-14	0.06~0.16x	74.1x96.0~26.1x33.9
	E-28	0.11~0.22x	37.0x48.0~19.3x25.0
	E-42	0.17~0.28x	24.7x32.0~15.3x19.9

Motor Drive E

Provides fully motorized operations, with electrical signals fully synching operations for automatic winding, continuous motorized shooting and remote control operations.

- Can be used with all shutter speeds (even in the AE mode).
- Has release button, remote control terminals, external power terminals and hot shoe.



Professional Lens Hood E



Free extensions possible, with distracting glare and reflections cut while checking effect in the finder.

Usable Lens: Zenzanon-E 40~250mm
 Max. Bellow Extension: 46mm
 Filter: Square gelatin filters of 75x75mm
 Size: 118(W)x120(H)x79(L)mm (when collapsed)
 Weight: 230 grams

Remote Camera Battery Pack E



Used for keeping battery warm next to your body in freezing temperature, when there is a drop in battery performance, with cord connection to the camera.

Focusing Lever E



Used on the focusing ring of the lens, for providing speedy, smooth focusing action. For Zenzanon-E lenses from 40mm to 250mm.

Tripod Adapter E (For Polaroid Film Back)



Since the Film Back extends below the camera body, the accessory is used on large tripod heads to raise the Film Back above the tripod head face.

ZENZA
BRONICA ETRS SYSTEM

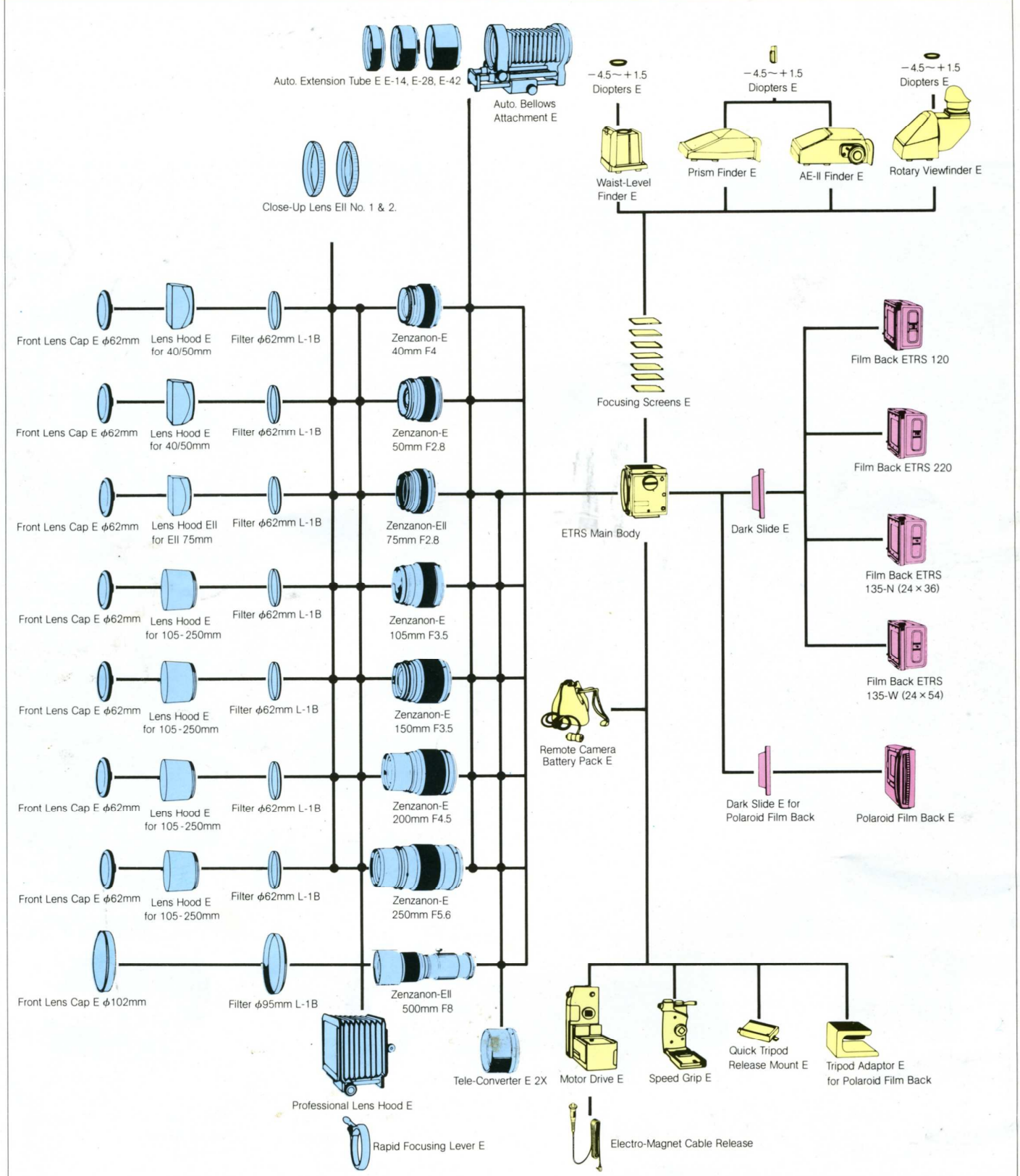

Changes in specifications and/or designs may be made without advance notice.

BRONICA CO., LTD.

662 Bijogi, Toda-shi, Saitama-Prefecture 335, Japan
 Telephone: (0484) 22-0003
 Cable Address: "BRONICA WARABI"
 Telex Call No. 02962733 BRONC J
 Fax: (0484) 21-2413

U.S. Distributor:
GMI Photographic, Inc.
 P.O. Drawer U, 1776 New Highway,
 Farmingdale, New York 11735
 TEL: (516) 752-0066
www.ianbfoto.com